

Wetwall<sup>®</sup>  
— A WILSONART COMPANY —



WATER-PROOF  
WALL PANEL SYSTEM  
PATENTED TECHNOLOGY



## WETWALL INSTALLATION GUIDELINES

# TOOLS AND MATERIALS

---

## REQUIRED TOOLS AND MATERIALS

### Wetwall Installation

#### TOOLS

- Pencil or Sharpie Marker
- Drill
- Hole Saw (woodworking)
- Circular Saw
- Use the Right Blade: Choose a fine-toothed blade designed for laminate, such as a carbide-tipped blade with 40-80 teeth (depending on the tool). High tooth counts reduce tear-out by making smaller, cleaner cuts. For circular saws or jigsaws, look for blades labeled "laminate" or "fine finish."
- Chalk-Line
- Tape Measure
- Heavy-Duty Caulking Gun  
(Ideal for knife-grade adhesives/battery-powered optional)
- Level
- Square
- J Roller (3 inch) for adhesive pressure

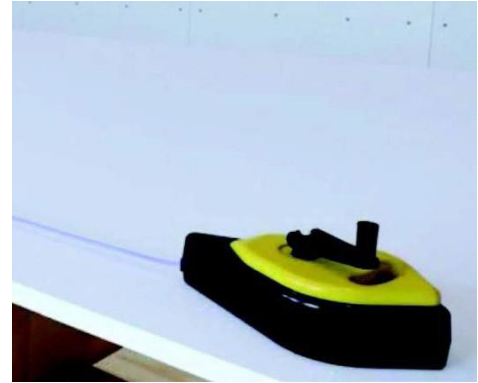

#### MATERIALS

- Denatured Alcohol + Spray Bottle
- 1/8" Shims
- Clean White Rags/Paper Towels
- Wetwall Panels
- Wetwall Panel Adhesive
- Wetwall Color Coordinated Sealant

#### PERSONAL PROTECTIVE EQUIPMENT RECOMMENDATION

- Safety Goggles
- Protective Gloves
- Protective Footwear

#### OPTIONAL TOOLS

- Router
- Suction Cups
- Jigsaw
- 1/2" shank - 2-flute router bit
- Hand Sander with 60 grit sandpaper
- Multi-tool



## BEFORE YOU CUT

### Cutting Wetwall Waterproof Panels

- **Circular Saw:** When using the circular saw, position the panel with the decorative side facing **down**.
- **Table Saw:** When using the table saw, position the panel with the decorative side facing **up**.
- **Jigsaw:** Cut with the decorative side **up**. Jigsaws cut on the upstroke, so tear-out happens on the bottom. Use a down-cutting jigsaw blade if available, as it pushes fibers downward for a cleaner top edge.
- **Router:** Choose the Right Router Bit: Use a sharp, carbide-tipped straight bit or a flush-trim bit designed for laminate. Bits with a high cutting angle (like spiral up-cut bits) can help, but for laminate, a compression bit (up-cut and down-cut combined) is ideal—it pulls fibers toward the center of the cut, reducing tear-out on both sides.
- **Optional:** It may be necessary to score the Cut Line. Before cutting, use a sharp utility knife or a laminate scoring tool to lightly score along the cut line on the laminate's surface. This breaks the top layer and prevents it from chipping when the saw passes through.
- **Optional:** Apply painter's tape. Place a strip of painter's tape (low tack, like blue tape) over the cut line. This helps hold the laminate fibers in place and reduces tear-out. Mark your cut line on the tape with a pencil for visibility.
- **Tip:** When cutting a bullnose panel, cut into the bullnose edge first.

For best results, combine these methods based on your tools. If you are getting tear-out, double-check your blade's sharpness—dull blades are a common culprit.

## GUIDED INSTALLATION VIDEO

Visit [www.wetwall.com/installation](http://www.wetwall.com/installation) for a guided installation video.

# STORAGE & PREPARATION

## STORAGE & PREPARATION

### Wetwall Installation

#### STORAGE

- Wetwall should be stored flat in a controlled, moderate climate.
- Avoid storage in areas with excessive heat or humidity.
- Acclimate all materials for a minimum of 48 hours in the environment where they will be installed.
- Do not store materials near exterior doors or in areas exposed to rain or temperature/humidity fluctuations.

#### BEFORE YOU BEGIN

- To ensure proper installation, read these instructions thoroughly. Some installations may require professional assistance. Always follow local plumbing and building codes.
- Unpack and inspect all Wetwall panels for damage.
- Verify wall dimensions against your Wetwall configuration and refer to the Technical Data Sheet for panel sizing.

#### PREPARATION

##### Approved Substrate Surfaces:

- Wetwall panels must be installed over:
  - Greenboard
  - Cement board or concrete board
  - Tile
  - Sheetrock is only acceptable in non-wet areas.

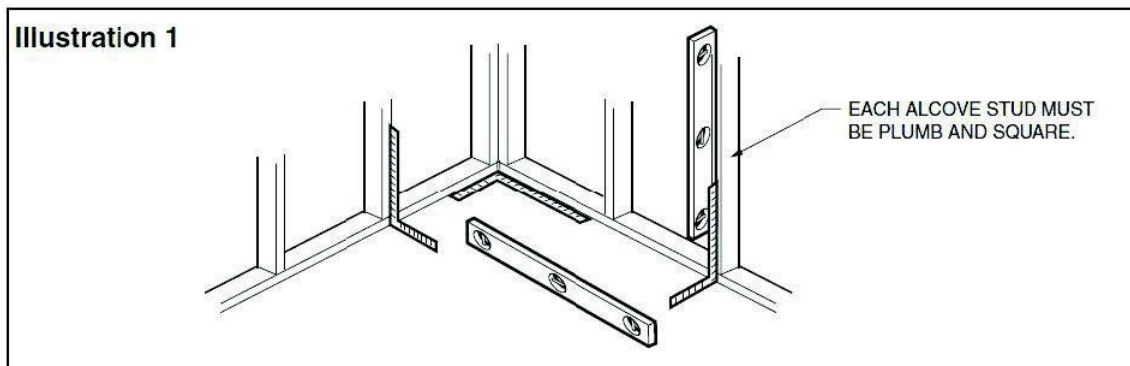

#### EXISTING WALL SURFACE PREP

- Wall surfaces must be dry, smooth, and free of dust, soap scum, mold, or any contaminants.
- Wipe surfaces with a damp cloth and let them fully dry before panel installation.
- Ensure the alcove is plumb and square.  
*(See Illustration 1)*

## PREPARATION

### Wetwall Installation

#### ROUGH PLUMBING & FITTING

- Turn off hot and cold-water supplies.
- Remove faucet handles, escutcheons, filler spouts, and any other fixtures. (e.g., towel bars, soap dishes).
- Use a hammer and chisel to remove objects cemented to the walls.

#### INSTALLATION OVER OLD TILE

- Do not remove old ceramic tile if it is solidly adhered to the wall.
- Remove any loose tiles, then sand the sub wall smooth before continuing.
- For glossy tile surfaces, rough up the surface using a belt sander with 60-grit sandpaper.
- Ensure the surface is dry, smooth, and free of dust or contaminants.
- Wipe surfaces with a damp cloth and allow them to fully dry before panel installation.

## DRY FITTING THE TONGUE-AND-GROOVE PANEL SYSTEM

### Wetwall Installation

#### STEP 1: Dry Fit Rear Panels

- Start with the back panels.
- Maintain a 1/8" (3mm) gap from:
  - Tub deck
  - Shower base
  - Side walls
- Mark seam/joint locations with a pencil on drywall for panel adhesive reference.
- Install the groove profile panel first, then slide the tongue profile panel into it. *(This ensures a tighter easier fit. (See Illustration 2))*



#### Additional Notes:

- Unpack and inspect the Wetwall panels for damage.
- Verify wall dimensions are the correct size for your installation (refer to the Wetwall Technical Data Sheet).
- Use suction cups for easier handling and seam alignment.

Illustration 3

#### STEP 2: Dry Fit Side Panels

- Dry fit both side panels.
- Identify and position the finished/reveal edge:
  - Use this on the entrance edge for a clean look without trim.
- If walls or tub are out of square:
  - Trim from the bottom of side panels so their top aligns with the back panel top. *(See Illustration 3)*

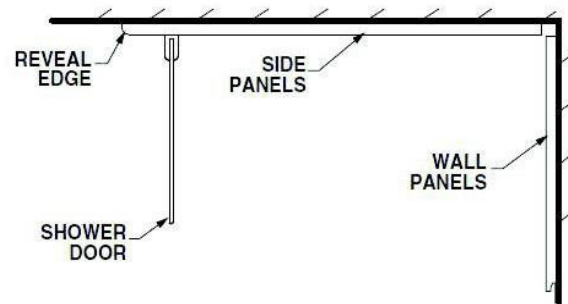

#### STEP 3: Mark and Drill Plumbing Locations

- Mark all necessary plumbing cutouts:
  - Shower valves
  - Showerheads
- Use a hole saw to drill:
  - Large enough for fixtures
  - Small enough to be covered by trim plates
  - Drill from the decorative side to avoid chipping. *(See Illustration 4)*
- Drill from the decorative side. *(See Illustration 4)*

Illustration 4

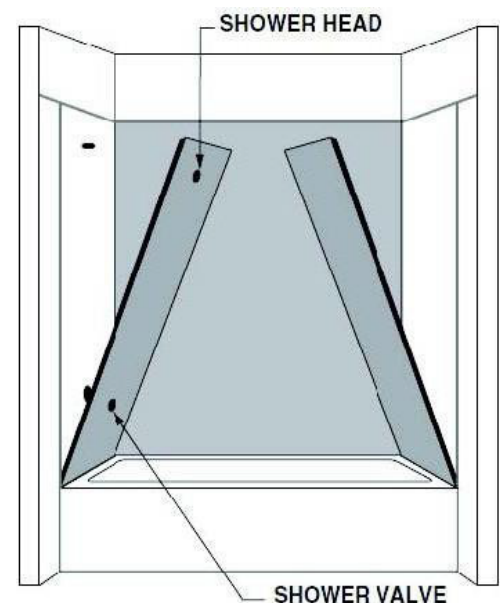

# PANEL ADHESIVE APPLICATION

## PANEL ADHESIVE APPLICATION

Wetwall Installation - Using Wilsonart Adhesive on Approved Sub Walls & Tongue-and-Groove Panels

*NOTE: Must use Wilsonart Adhesive. Apply adhesive to one panel at a time. Do not allow adhesive beads to connect or overlap. Use of a heavy-duty caulking gun is recommended for knife-grade adhesives.*

### STEP 1: Surface Preparation

- Clean the backsides of all panels and the installation wall with a damp white cloth and denatured alcohol to remove any dust or debris.
- Allow all surfaces to fully dry before continuing.

### STEP 2: Apply Adhesive to Rear Wall

- Begin with the rear/back panel(s).
- On the approved sub wall (e.g., drywall, greenboard), apply an adhesive bead  $1\frac{1}{2}$ " (38mm) in from each edge of the panel location.  
(See Illustration 5).
- Add horizontal beads  $\frac{1}{2}$ " (13mm) from the top and bottom edges.
  - Beads must be spaced 10"– 12" (250-304mm) apart between outer edges.
    - Panels 49" or wider: Apply 6 equally spaced beads.
    - Panels 31" to 48": Apply 5 equally spaced beads.
    - Panels 30" or less: Apply 4 equally spaced beads.
- All adhesive beads should be  $\frac{1}{4}$ " (5mm) wide and deep.

*IMPORTANT: Horizontal and vertical adhesive beads should not connect or touch—leave a small gap at intersections to avoid excessive buildup or adhesive bridging.*

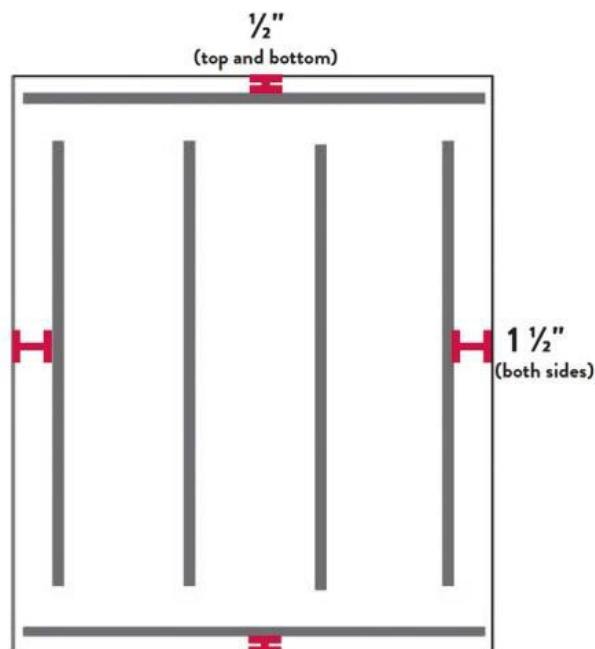

Illustration 5

# PANEL ADHESIVE APPLICATION

---

## STEP 3: Install First Rear Panel

- With suction cups, place the first rear panel on the wall:
  - For tongue and groove installation, install groove panel first.
  - Leave 1/8" (3 mm) gap above the tub deck, shower base, and wall flange.
- Use a J-roller to firmly press the panel over the entire surface to ensure good contact with the wall adhesive.

NOTE: *You may need to brace or support the panel until the adhesive holds.*  
(See Illustration 6)

## STEP 4: Install Second Rear Panel (for Tongue and Groove application, otherwise skip to Step 5)

- Apply panel adhesive as in Step 2.
- Place the second rear panel on the wall:
  - Leave 1/8" (3mm) space from the groove of the first panel.
  - Apply color coordinated sealant **to the tongue of the second panel** before joining.
- Gently close the seam — do not tap or force the panels together.
- Use a J-roller to firmly press the panel in place.
- Wipe away excess sealant between the tongue and groove using denatured alcohol.

## STEP 5: Install Side Panels

- Apply adhesive using the same method as above.
- Ensure the finished reveal edge is at the entrance of the tub or shower pan.
- Leave 1/8" (3 mm) gap above the tub deck, shower base, and wall flange.
- Remove excessive adhesive with denatured alcohol.

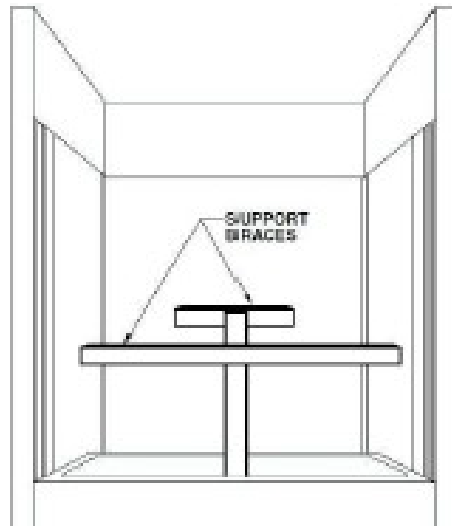

Illustration 6

# COLOR COORDINATED SEALANT APPLICATION

---

## COLOR COORDINATED SEALANT APPLICATION

### Wetwall Installation: Seams and Joints

Must use Wilsonart Sealant

**NOTE:** *Color coordinated sealant is best matched to the approximate color of panel being installed. This helps ensure sealant is not as visible.*

#### STEP 1: Applying Sealant to Seams and Joints

- Once all panels are securely in place and set, apply Wilsonart Color Coordinated Sealant to all corners, seams between panels and gaps between the bottom panels and the tub or shower pan (*See Illustration 7*).
- Wipe any excess sealant from the panel with denatured alcohol.

**IMPORTANT:** Do not seal the top edge of the Wetwall panel. It is intentionally left unsealed to allow for natural ventilation and moisture dissipation to mitigate mold or mildew growth over time. By allowing the top to be unsealed, the panel maintains its durability and ensures optimal performance in a humid environment.

#### STEP 2: Curing Time

- Allow 24 hours for both adhesive and sealant to fully cure before installing any shower accessories.

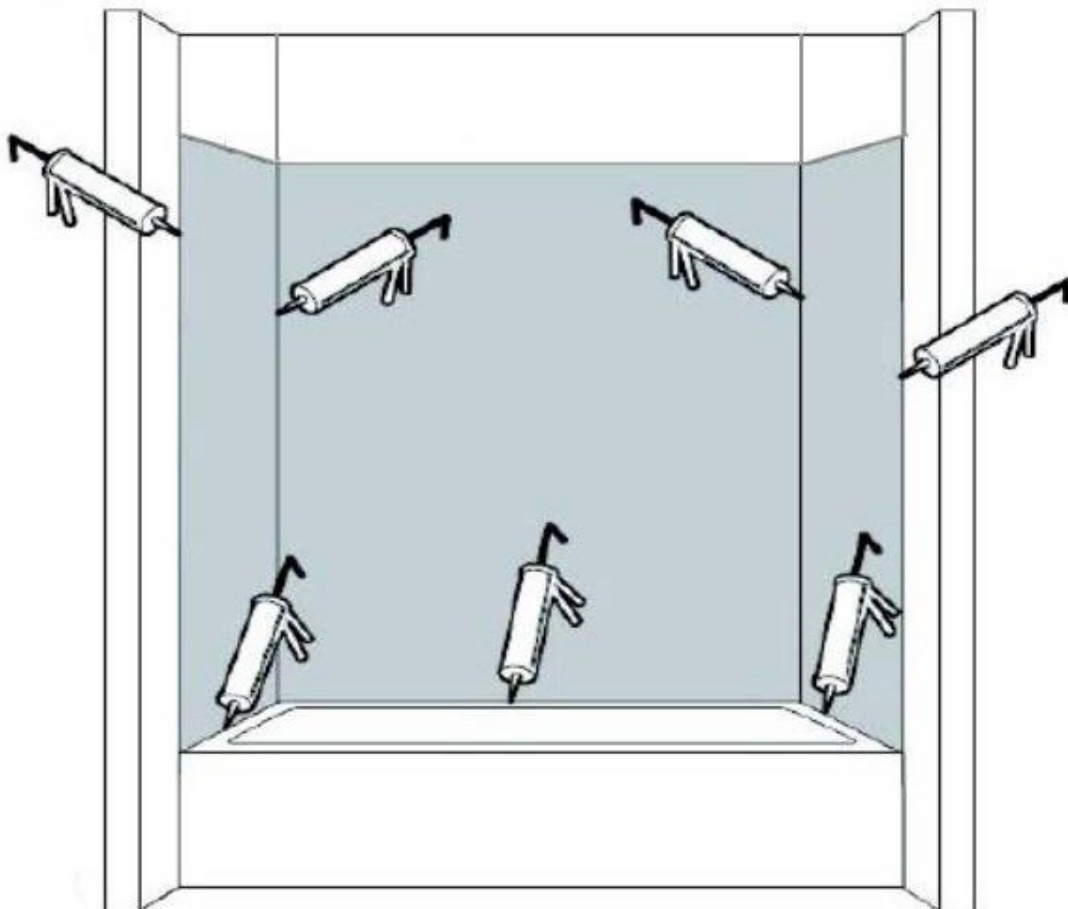

Illustration 7

# ACCESSORY INSTALLATION

---

## ACCESSORY INSTALLATION

### Wetwall Installation

Installing Shower Accessories (Shower Heads, Bath Spouts, Handles/Grab Bars, Niches, Shelves, Doors, and Curtain Rods)

*NOTE: Color coordinated sealant is colored or best matched to the approximate color of the panel being installed. This helps ensure sealant is not as visible.*

#### STEP 1: Preparation

- **Structural Support:** Prior to installing Wetwall panels, ensure that necessary structural framing is in place to anchor accessories (e.g., grab bars, niches, shelves, doors, and curtain rods) directly to the stud wall.

*NOTE: Wetwall panels are not designed to support the weight of any third-party accessory. All such accessories must be anchored to the structural framing behind the panel. However, Wetwall's recessed niches and corner shelves are engineered to be panel-supported and may be installed per Wetwall's instructions.*

#### STEP 2: Installation

- Follow the manufacturer's instructions for installing all accessories. 
- Review and follow all local and federal load requirements for grab bars. The screws will need to penetrate the Wetwall panel into the stud.
- Apply color coordinated sealant to:
  - All trim plates
  - Over the threads of mounting screws
  - Around the outside of each wall (to seal out moisture and water)
- Use oversized holes when drilling or using a hole saw in the Wetwall panel to allow for mechanical fasteners.

*NOTE: Allow 24 hours for the color coordinated sealant to dry before use.*

# CARE AND MAINTENANCE

---

## CARE AND MAINTENANCE

### Wetwall Installation

- Warm, soapy water and a sponge will be adequate for regular maintenance.
- Common non-abrasive household cleaners can be used with a soft sponge or cloth. It is recommended that all cleaners be rinsed immediately.
- Recommended cleaners: Lime-A-Way® Cleaner, Mr. Clean® Magic Eraser, Tilex® Bathroom Cleaner, Fabuloso® All-Purpose Cleaner, Fantastik® All-Purpose Cleaner, Windex® Multi-Surface Cleaner, Formula 409® Multi-Surface Cleaner, Simple Green® All-Purpose Cleaner, Pine-Sol® Multi-Surface Cleaner, Green Works® All-Purpose Cleaner, Spic and Span® Liquid Multi-Surface & Floor Cleaner.
- Do not use wire brushes, knives, or sharp objects to remove stains, cigarette tar deposits, or other surface blemishes.
- Abrasive cleaners or powders must not be used since they will dull the surface. Do not use Gritty Cleaners, Scotch-Brite™ Pads, Comet® Bleach Powder, Soft Cleanser, or Strong Solvents (Thinners, MEK).
- If bleach is used, diluting 1/4 cup of bleach to 1 gallon of water is recommended. Rinse at once, as prolonged exposure to bleach on the surface will cause discoloration.

For more information, please visit [www.wetwall.com](http://www.wetwall.com).